



Refrigerated Compressed Air Dryers

Models DRD 200, 250, 300, 400, 500, 750

Instruction Manual

Contents

GENERAL SAFETY INFORMATION	2
RECEIVING, MOVING, UNPACKING	2
1.0 INSTALLATION	3
2.0 OPERATION	5
3.0 MAINTENANCE	6
SIZING	6
ENGINEERING DATA	7
ELECTRICAL SCHEMATICS	8
DIMENSIONS / WEIGHTS	9
TROUBLESHOOTING	10
PARTS LIST	11
WARRANTY	12

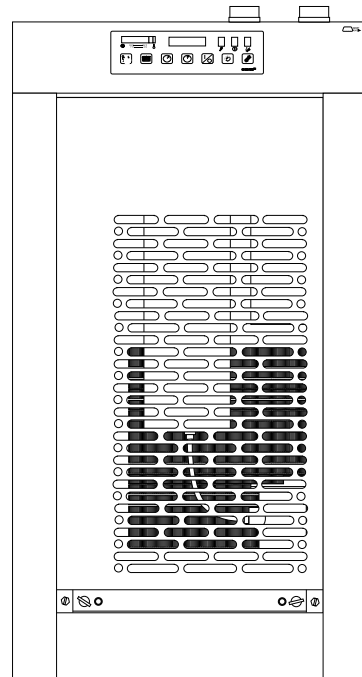

For Sales & Service Call: 705-722-5747 Ext.1

GENERAL SAFETY INFORMATION

1. PRESSURIZED DEVICES:

This equipment is a pressure containing device.

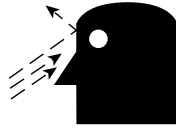

- Do not exceed maximum operating pressure as shown on equipment serial number tag.
- Make sure equipment is depressurized before working on or disassembling it for service.

2. ELECTRICAL:

This equipment requires electricity to operate.

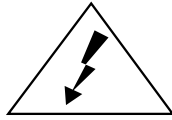

- Install equipment in compliance with all applicable electrical codes.
- Standard equipment is supplied with electrical enclosures not intended for installation in hazardous environments.
- Disconnect power supply to equipment when performing any electrical service work.

3. BREATHING AIR:

Air treated by this equipment may not be suitable for breathing without further purification.

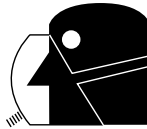

- Refer to applicable standards and specifications for the requirements for breathing quality air.

RECEIVING, MOVING, AND UNPACKING

A. RECEIVING

This shipment has been thoroughly checked, packed and inspected before leaving our plant. It was received in good condition by the carrier and was so acknowledged.

Check for Visible Loss or Damage. If this shipment shows evidence of loss or damage at time of delivery to you, insist that a notation of this loss or damage be made on the delivery receipt by the carrier's agent.

B. UNPACKING

Check for Concealed Loss or Damage. When a shipment has been delivered to you in apparent good order, but concealed damage is found upon unpacking, notify the carrier immediately and insist on his agent inspecting the shipment. Concealed damage claims are not our responsibility as our terms are F.O.B. point of shipment.

C. MOVING

In moving or transporting dryer, do not tip dryer onto its side.

D. STORAGE

IMPORTANT: Do not store dryer in temperatures above 130°F, 54.4°C.

For Sales & Service Call: 705-722-5747 Ext.1

IMPORTANT: READ PRIOR TO STARTING THIS EQUIPMENT

1.0 INSTALLATION

1.1 Location

- A. For typical placement in a compressed air system, see drawing.
 - B. Air compressor intake—Locate air compressor so that contaminants potentially harmful to the dryer (e.g. ammonia) are not drawn into the air system.
 - C. Clearances Free air flow
 - Models 200, 300
 - Front 24 inches (610 mm)
 - Back 12 inches (305 mm)
 - Sides 24 inches (610 mm)
 - Models 400 to 750
 - Front 12 inches (305 mm)
 - Back 12 inches (305 mm)
 - Sides 36 inches (915 mm)
- Service - To facilitate maintenance leave 24 inches (610 mm) of clearance in front of dryer.

- D. Standard units are designed to operate in ambients:
 - Air-cooled: 45 to 110°F (7 to 43°C).
 - Water-cooled: 45 to 130°F (7 to 54°C).
- E. Installations in altitudes above 4500 feet (1370 meters) – Dryer is adjusted to operate in altitudes up to 4500 feet(1370 meters). If dryer is installed in an altitude above this, and has not been preset at the factory for this altitude, contact manufacturer's Service Department.

NOTE: Outdoor installation—Standard units are designed for indoor installation. Contact manufacturer if installing outdoors.

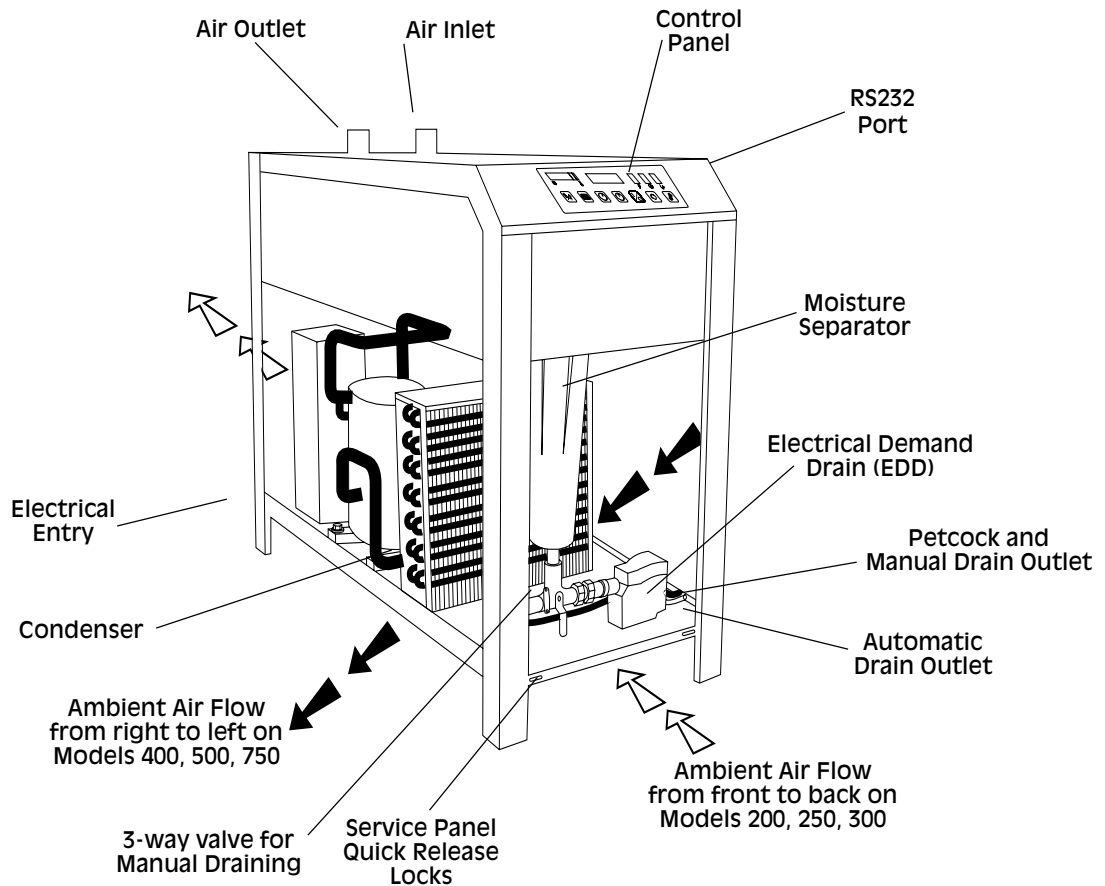
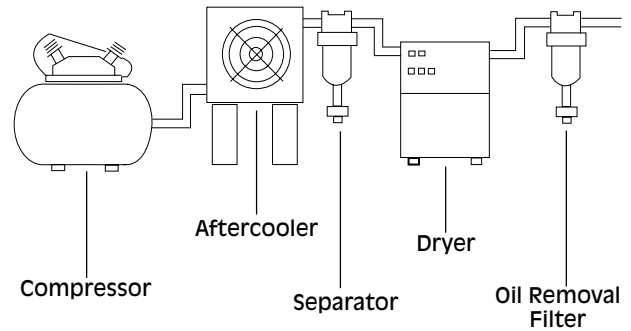

For Sales & Service Call: 705-722-5747 Ext.1

1.2 Mounting

Mount on floor or shelf free from vibration.

1.3 Piping connections

- A. Air Inlet—Connect compressed air line from air source to air inlet.

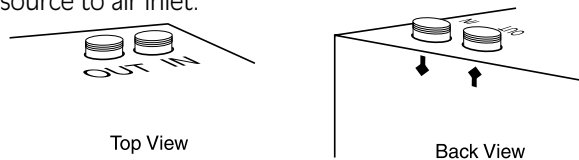

⚠ WARNING Refer to Serial Number Tag for maximum working pressure. Do not exceed dryer's Maximum Working Pressure.

NOTE: Install dryer in air system at highest pressure possible (e.g. before pressure reducing valves).

NOTE: Install dryer at coolest compressed air temperature possible. Maximum inlet compressed air temperature: 120°F (49°C). If inlet air exceeds this temperature, precool the air with an aftercooler.

- B. Air Outlet—Connect air outlet to downstream air lines.
C. By-pass piping—If servicing the dryer without interrupting the air supply is desired, piping should include inlet and outlet valves and an air by-pass valve.
D. Water cooled models—cooling water inlet and outlet
1. Connect cooling water supply to cooling water inlet.
2. Connect cooling water return line to cooling water outlet connection.

NOTE: Strainer and water regulating valve are supplied on water cooled models.

1.4 Electrical connections

IMPORTANT: Use copper supply wires only.

- A. Dryer is designed to operate on the voltage, phase, and frequency listed on the serial number tag.
B. Connect power source to terminal strip in electrical enclosure.

NOTE: Refrigeration condensing unit is designed to run continuously and should **NOT** be wired to cycle on/off with the air compressor.

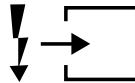

1.5 Moisture separator

- A. An automatic electric demand drain (EDD) discharges condensate removed by the separator. It may be desirable to pipe the condensate from the EDD outlet to a suitable drain.
- B. For manual draining, convenient dryer depressurization, and EDD service, a three-way valve at the bottom of the moisture separator and before the EDD is installed. For manual draining, turn the valve handle so it is in a horizontal position. Open the petcock on the side of the dryer base pan to discharge the condensate or to depressurize the dryer if it has been by-passed. The petcock can be left in a throttled (partially opened) position should there be a problem with EDD.

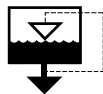

NOTE: Discharge is at system pressure. Drain line should be anchored.

NOTE: Condensate may contain oil. Comply with applicable laws concerning proper disposal.

4 For Sales & Service Call: 705-722-5747 Ext.1

1.6 Electronic Demand Drain

Installation

1. Remove Service Panel by removing two shipping screws and turning (2) Quick Release Locks.
2. Reach inside and remove screws on Separator/filter shipping support bracket and remove bracket.
3. Reach behind filter and cut plastic shipping strap holding Energy Saving Demand Drain.
4. Insert Demand Drain into brass quick disconnect on bottom of Separator/filter.
5. Remove manual petcock from drain hose and mount into manual outlet drain connection on outside of side panel.

Operation

- A. Verify that isolation valves are open. If the drain fails to discharge after the valve is energized, the electronic control circuit will repeatedly energize the valve in an attempt to clear the discharge port. If, after 60 seconds, the drain still fails to discharge, the control circuit then switches to the alarm mode. In this mode the valve is de-energized and the red alarm light is activated on the drain and the dryer controller. The valve is then automatically energized every 4 minutes for 5 seconds. Check the drain operation. Push drain (push-to-test) button on the emm Energy Management Monitor control board to energize drain. A flow of condensate and/or air should be present at the drain outlet. The alarm mode automatically clears after the drain returns to normal operation.
- B. Condensate enters the reservoir (1) through the inlet port. When the condensate level in the reservoir covers the capacitance sensor, an electronic signal is sent to the solid state countdown processor. The processor delays the opening of the solenoid valve for a given period of time. Once the time has elapsed, the solid state processor transmits information to energize the coil in the solenoid valve (2). The magnetic force of the coil causes the solenoid core (3) to move, closing the pilot air supply line and opening the pilot air exhaust line. After the pilot air above the diaphragm (4) is vented, pressure in the reservoir opens the discharge port and forces the condensate through the discharge port and outlet piping.

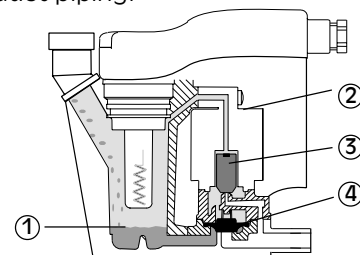

2.0 OPERATION

2.1 Minimum/Maximum operating conditions

- A. Maximum inlet air pressure: refer to dryer serial number tag
B. Minimum inlet air pressure: 30 psig (2.1 kgf/cm²)
C. Maximum inlet air temperature: 120°F (49°C)
D. Maximum ambient temperature:
Air-cooled models: 110°F (43°C)
Water-cooled models: 130°F (54°C)
E. Minimum ambient temperature: 45°F (7°C)

2.2 Start-up

A. Energize dryer. Green power on light will illuminate.

IMPORTANT: Energize dryer disconnect switch 24 hours before refrigeration compressor is started! Never use the disconnect switch to shut-down the dryer for an extended period of time (except for repair). Failure to follow these instructions may result in a non-warrantable compressor failure.

B. Program monitor.

1. Language selection:

A choice of 5 languages (English, Spanish, French, Italian, and German) is available for the Interface panel. Select language desired by:

- a. Push Day of Week and Hour buttons simultaneously until menu appears
- b. Use Day of week button to scroll through choices
- c. Push Set/Run button to accept selection

2. Setting clock functions:

- a. Select Set Mode by pushing Set/Run button and holding for 3 seconds
- b. SET TIME - set current time using: Day of Week button - Hour button (24 hour clock; 10:00 PM is 22:00 hours)- and Minute button
- c. SET SCHEDULE - Push Set/Run button again to SET SCHEDULE - The monitor can turn the refrigeration compressor on and off once per day. To utilize this feature:
 - 1) Select day of week using Day of Week button
 - 2) Set time refrigeration compressor is to turn on using Hour and Minute buttons

NOTE: It is recommended that dryer be started 15 minutes before compressed air flow begins.

NOTE: Toggle between on and off using On/Off button

- 3) Toggle to off setting and set time refrigeration compressor is to turn Off

NOTE: If you wish to have the dryer remain Off or On for the day selected, choose the IGNORE ON or IGNORE OFF command that appears after 24:00 hours.

- 4) Repeat Steps 2) and 3) for the remaining days of the week
- d. SET SERVICE - Push Set/Run button again to SET SERVICE - Enter the number of operating hours (service interval) before service reminder is initiated. Use Hour button to advance in hundred hour intervals and Minute button to advance in ten minute intervals. Maximum setting is 4090 hours. (Only hours that refrigeration compressor is operating are counted)

NOTE: On dryers with air-cooled condensers, regular condenser cleaning is recommended. Dirtiness of ambient air at installation site will determine frequency of service. Typically once a month is recommended. Dryers contain an integral 3 micron filter. As the filter element accumulates solid contaminants, differential pressure increases. Solid particulate load in the compressed air supply will determine frequency of service. Typically element changeout is recommended at least annually.

e. Push Set/Run button again to exit Set Mode.

NOTE: If dryer is left in the Set Mode for longer than 30 seconds, Alarm light will illuminate and TIME OUT will appear on the Interface panel. Dryer will resume previous operating mode.

C. Starting dryer

IMPORTANT: Dryer must be energized 24 hours before starting refrigeration compressor.

NOTE: It is recommended that dryer be started 15 minutes before compressed air flow begins.

1. On water-cooled models: after 24 hours, begin cooling water flow.
2. Dryer may be operated in Manual or Scheduled modes
Manual mode - push On/Off button - refrigeration compressor will start and run, green Compressor-on light will illuminate. In this mode compressor will run continuously and will not be turned on and off by the monitor. MANUAL OVERRIDE will appear on interface panel.
Schedule mode - push Set/Run button. SCHEDULE RUNNING will appear on the interface panel. The refrigeration compressor will continue to be on or off (as selected in the Manual Override Mode) until the next scheduled event. The compressor will then turn on or off as programmed.

NOTE: Schedule may be returned to the manual mode at any time using the On/Off button. MANUAL OVERRIDE will appear on interface panel. To re-institute Schedule, push the Set/Run button again.

NOTE: Restart after the power interruption. Unit will be in MANUAL OVERRIDE mode, refrigeration compressor, off when power is restored after power interruption.

3. To re-institute SCHEDULE RUNNING:
If compressor is scheduled to be off - push Set/Run button to restart schedule. If compressor is scheduled to be on - push On/Off button to manually start compressor, then push the Set/Run button to restart schedule.

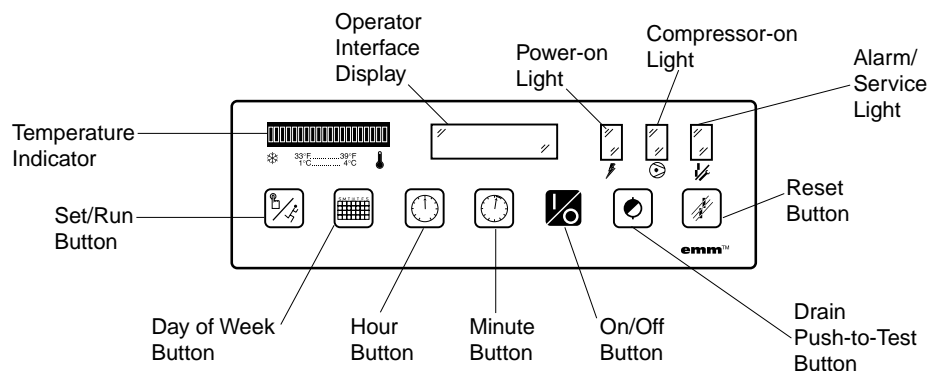

- D. Operating check points
1. Check that green Power-on light is illuminated
 2. Check that green Compressor-on light is illuminated if dryer is on in the manual mode or it is a scheduled on time

IMPORTANT: Refrigeration compressor must be restarted after power interruption.

3. Check interface panel

NOTE: Interface panel will switch between Current Time/ Operating Status screen and Hours to Service/Total Operating Hours (HRS TO SVC/TOTAL) screen. TOTAL is cumulative hours of refrigeration compressor operation.

- a. Verify that current time is correct
- b. Check HRS TO SVC: this indicates time remaining until service is required; allow time for required maintenance items to be ordered
- c. Check operating status:
MANUAL OVERRIDE - Dryer is either running continuously (not being controlled by the scheduled on/off times) or the refrigeration compressor has been shut off using the On/Off button.
SCHEDULE RUNNING - Refrigeration compressor is being turned on and off by the monitor per-programmed schedule (see B.2. to set schedule)
- d. Check Temperature indicator - indicator should read in the green area
- e. Check Alarm/Service light If illuminated, check Interface panel.
 - 1) If SERVICE DRYER appears, scheduled maintenance time has elapsed (HRS TO SRV is 0). Perform needed service and reset service interval (see B.2.).
 - 2) If ALARM appears, a dryer fault is indicated; see Trouble-shooting Guide for possible remedies. After fault correction push Reset button to turn Fault alarm off.

FAULTS

LOW PRESSURE - the refrigeration compressor control circuit has opened because of low suction pressure. Compressor will restart automatically when fault is corrected.

HIGH PRESSURE - the refrigeration compressor control circuit has opened because of high head pressure. The high pressure switch must be reset manually once the fault is corrected. Red reset button is located on pressure switch inside unit.

LOW TEMPERATURE - compressed air temperature is below the set point

NOTE: If temperature probe is open, one light on lefthand side of Temperature indicator will be illuminated.

HIGH TEMPERATURE - compressed air temperature is above the set point.

NOTE: If temperature probe is shorted, Temperature indicator will be completely illuminated.

DRAIN - electric drain contains a high water level alarm that activates if drain fails to discharge.

- f. Check drain operation - push Drain (push-to-test) button to energize electric drain. A flow of condensate and/or air should be present at the drain outlet.

- E. Using the RS-232 port
- The RS-232 port is used to monitor dryer operation from a host computer. A (1 to 1) DB-9 cable is required to connect dryer and computer. For PC connections, data is transmitted on pin 2, received on pin 3, ground is pin 5, pins 7 and 8 are jumpered at dryer.

Operation is at fixed baud rate of 2,400; asynchronous format is 8 bit, no parity, 1 stop bit ("8,N,1"). No checksum or error correction values are provided. If required, request status string two (or more) times and compare for agreement.

Request data by sending ASCII ? character (3FH). Response may take up to two seconds as certain processing functions may require completion before serial port is acknowledged.

Dryer responds with line feed (0AH), carriage return (0DH), and character string:

(1) (2) (3) (4) (5) (6) (7)
XXX, X, XXX, X, XXXX, XXXX, X

- (1) Number of Temperature Indicator LEDs illuminated (1-20)
- (2) Compressor state, C=X (1or 031H = ON, 0 or 030H= OFF)
- (3) Sum of alarm weights, A=XXX (0 - 255;

e.g. high pressure and service alarms = 132 [4 + 128])

Bit	Weight	Alarm
2	4	High press. alarm (1 = alarm)
3	8	Low press. alarm (1 = alarm)
5	32	Drain alarm (1 = alarm)
7	128	Service (service required) alarm (1 = alarm)

For low and high temperature alarm, assign alarm to number of Temperature Indicator LEDs illuminated:
3 = low, 20 = high

- (4) Day of week (1 = Sunday, 7 = Saturday)
- (5) Time (24 hour format, hour, minutes)
- (6) Hours to service (0-9999)
- (7) Operating mode, M=X (S = schedule running, M = manual override)

- F. Using the auxiliary contacts
- The monitor is equipped with an auxiliary set of dry (volt-free) contacts (one set of normally open contacts, one set of normally closed contacts) which can be used to operate an auxiliary device (e.g., an air line solenoid valve). Rating: 5 amps @ 24VDC or 240VAC

1. These contacts can be activated in one of the following modes:

Schedule Driven Mode - the contacts will be energized and de-energized according to the schedule inputted by the operator of the dryer. If the refrigeration compressor shuts down on a fault condition, the contacts will remain energized (or de-energized) according to the schedule. The contacts will operate independently of the refrigeration compressor in both the manual override and schedule running modes.

NOTE: The schedule driven mode is the factory default setting.

Dryer Driven Mode- the contacts will be energized and de-energized in parallel with the refrigeration compressor of the dryer. Therefore, if the refrigeration compressor is on, the contacts are energized; if the refrigeration compressor is off (manually or by a system fault condition), the contacts will be de-energized.

NOTE: It is the responsibility of the end-user to properly design the system control circuitry when using the auxiliary contact feature.

To select Schedule Driven or Dryer Driven modes:

1. De-energize unit and disconnect the power supply to the dryer.
2. Remove the cabinet panels as necessary to provide access to the Monitor panel.
3. On the rear of the circuit board, locate the jumper pins labeled JA and JB.
4. Move the jumper to the appropriate setting:
Schedule Driven: jumper position JA
Dryer Driven: jumper position JB
5. Wire the auxiliary device into the terminals 1 (Normally Open), 2 (Common) and/or 3 (Normally Closed) on the terminal block TB2. See wiring diagram for details.
6. Reinstall the cabinet panels.
7. Energize the unit.

3.0 MAINTENANCE

3.1 Condenser coil—Clean off accumulated dust and dirt monthly.

3.2 Moisture separator—Replace filter element when pressure drop across dryer is excessive or annually.

3.3 Check separator daily to be sure automatic drain is discharging.

3.4 Blow down separator weekly by pushing test button on control panel.

3.4 Rebuild drain mechanism annually.

To facilitate service, maintenance kits are available.

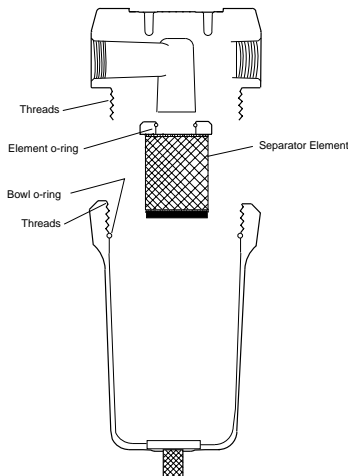

SIZING

Determining dryer capacity at actual operating conditions

To determine the maximum inlet flow capacity of a dryer at various operating conditions, multiply the rated capacity from Table 1 by the multipliers shown in Table 2.

Example: How many scfm can an air-cooled model 400 handle when compressed air to be dried is at 200 psig and 100°F; ambient air temperature is 80°F; and a 40°F dew point temperature is desired?

Answer: 400 x 1.22 x 1.12 x 1.1 = 601 scfm.

TABLE 1

Rated capacity (scfm) and pressure drop @ 100 psig inlet pressure, 100°F inlet temperature, and 100°F ambient temperature

MODEL		200	250	300	400	500	750
Rated capacity of	60 Hz	200	250	300	400	500	750
air-cooled models (scfm)	50 Hz	170	210	250	340	420	630

TABLE 2

Air capacity correction factors (Multipliers)

PRESSURES		INLET COMPRESSED AIR CONDITIONS				
		INLET TEMPERATURES				
psig	kgf/cm ²	80°F 27°C	90°F 32°C	100°F 38°C	110°F 43°C	120°F 49°C
50	3.5	1.35	1.05	0.84	0.69	0.56
80	5.6	1.50	1.17	0.95	0.79	0.66
100	7.0	1.55	1.23	1.00	0.82	0.70
125	8.8	1.63	1.31	1.07	0.91	0.74
150	10.5	1.70	1.37	1.13	0.95	0.80
175	12.3	1.75	1.42	1.18	0.99	0.84
200	14.0	1.80	1.47	1.22	1.03	0.89

COOLING MEDIUM*			OUTLET DEWPOINT		
AMBIENT TEMPERATURE		MULTIPLIER	DEWPOINT TEMPERATURE		MULTIPLIER
°F	°C		°F	°C	
80	27	1.12	38	3	1.0
90	32	1.06	40	4	1.1
100	38	1.00	45	7	1.2
110	43	0.94	50	10	1.3

*Air-cooled models; water-cooled models use 1.15 multiplier if cooling water is below 35°C, 95°F.

For Sales & Service Call: 705-722-5747 Ext.1

ENGINEERING DATA

MODELS	200	250 & 300	400 & 500	750
MINIMUM - MAXIMUM OPERATING CONDITIONS				
Min.-Max. Inlet Air Pressure (compressed air at inlet to dryer)	30-200 psig (2.1-14 kgf/cm ²)			
Max. Inlet Air Temperature (compressed air at inlet to dryer)	120°F (49°C)			
Min.-Max. Ambient Temperature				
Air-cooled	45°F (7°C) - 110°F (43°C)			
Water-cooled	45°F (7°C) - 130°F (54°C)			
REFRIGERATION SYSTEM DATA				
Compressor Type				
Refrigeration Compressor Horsepower	1	1-1/2	2	3
BTU/HR - Refrigeration Only @ 35°F Evaporator & 100°F Ambient 60/50 Hz	8660 / 7217	15600 / 13000	17400 / 14500	26700 / 22250
Outlet Air Temperature (nominal at rated conditions)	85°F (29°C)			
Refrigerant Type	R-134a			
Refrigerant Charge	See dryer serial number tag			
Suction Pressure Setting (controlled by hot gas by-pass valve)	31.5	31.5	31.5	31.5
Compressor Control Ranges (psig) (out-in)	High			
	281-190	281-190	281-190	281-190
	Low			
	24-34	24-34	24-34	24-34
Condenser Fan Switch Setting (in-out)(psig)	Fan 1			
	113-78	113-78	113-78	113-78
(air-cooled models)	Fan 2			
	-	-	183-124	183-124
Air Flow Across Condenser (cfm) (air-cooled models) 60/50 Hz	672 / 560	1093 / 911	2650 / 2208	2650 / 2208
Condenser Cooling Water Requirements (water-cooled models)				
Recommended Water Pressure (psig)	40 Min. - 120 Max*			
Gallons Per Minute Of Flow Required With 85°F Cooling Water 60/50 Hz	2.9/2.4	4.8/4.0	5.8/4.8	12/10
Inlet Water Connection	1/2" Female			
ELECTRICAL				
Nominal Voltage	208-230/3/60	208-230/3/60	208-230/3/60	208-230/3/60
Max. - Min. voltage	253-187	253-187	253-187	253-187
Rated Load Amps**	8.4	11.5	13.6	22.9
Locked Rotor Amps**	51	65.5	75	90
Minimum Circuit Ampacity	10.5	16.9	17.1	31.7
Branch Circuit Fuse Size (amps)	15	20	25	45
Watts @ 35°F Evaporator & 100°F Ambient	1335	1940	2620	3600
Resistance (Ohms) Three phase (Total)	1.77	1.256	1.058	0.853
Nominal Voltage	460/3/60	460/3/60	460/3/60	460/3/60
Max. - Min. Voltage	506-414	506-414	506-414	506-414
Rated Load Amps**	4.0	4.9	6.2	11
Locked Rotor Amps**	25	33	40	45
Minimum Circuit Ampacity	5.2	9.2	9.6	15.6
Branch Circuit Fuse Size (amps)	15	15	15	20
Watts @ 35°F Evaporator & 100°F Ambient	1335	1940	2620	3600
Resistance (ohms) Three phase (Total)	7.44	4.95	4.11	0.853
Nominal Voltage	380-420/3/50	380-420/3/50	380-420/3/50	380-420/3/50
Max. - Min. Voltage	462-342	462-342	462-342	462-342
Rated Load Amps**	4.0	4.9	5.7	9.9
Locked Rotor Amps**	25	33	45	45
Minimum Circuit Ampacity	5.2	9.2	9.6	15.6
Branch Circuit Fuse Size (amps)	15	15	15	20
Watts @ 35°F Evaporator & 100°F Ambient	1068	1552	2096	3030
Resistance (ohms) Three phase (Total)	7.44	4.95	4.11	0.853
Nominal Voltage	575/3/60	575/3/60	575/3/60	575/3/60
Max. - Min. Voltage	632-518	632-518	632-518	632-518
Rated Load Amps**	3.2	3.9	4.6	7.9
Locked Rotor Amps**	25	33	40	45
Minimum Circuit Ampacity	4.2	7.4	7.7	12.8
Branch Circuit Fuse Size (amps)	15	15	15	15
Watts @ 35°F Evaporator & 100°F Ambient	1335	1940	2620	3600
Resistance (ohms) Three phase (Total)	7.44	4.95	4.11	0.853

* Allows continued operation with some restriction in the water strainer

** Air-cooled models only

For Sales & Service Call: 705-722-5747 Ext.1

ELECTRICAL SCHEMATIC

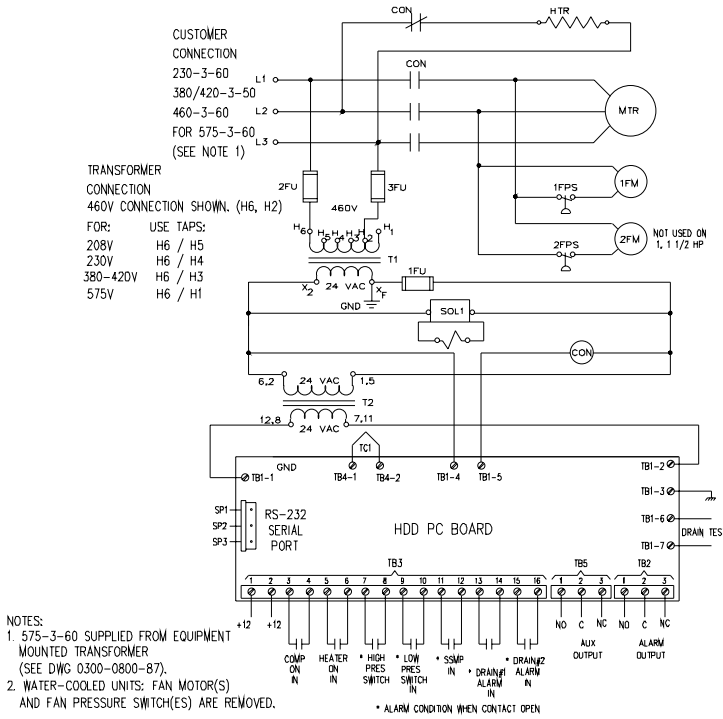

DIMENSIONS / WEIGHTS

Dimensions inches

Model	200-300	400-500	750
A	40-1/8	52-1/8	57-7/16
B	48	51	65
C	21-3/4	27-1/2	27-1/2
D	2-3/4	5	5
E	8	9	9
F	2-13/16	3-1/4	3-1/4
G	4-1/8	4-1/8	4-1/8
H	6-5/8	8	19-3/8
I	3-1/2	3-1/2	3-1/2
J	6-1/4	6-1/4	6-1/4
K	1-1/4	1-1/4	1-1/4
L	1-1/8	2-1/4	2-1/4
Inlet/Outlet Connections	2"	3"	3"

Model	200	250	300	400	500	750
Weight (lb)	405	415	416	457	498	625

NOTE: Dimensions and Weights are for reference only. Request certified drawings for construction purposes.

(1) Models 200, 250, 300 - Air flow is from the front to back of the dryer.

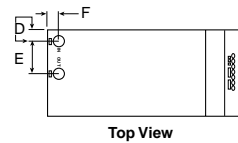

Models 400, 500, 750 - Air flow is from right to left of the dryer.

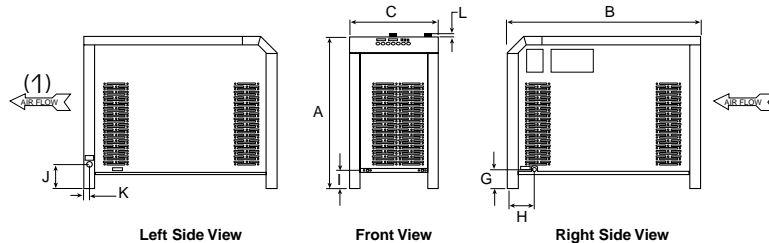

TROUBLESHOOTING GUIDE

SYMPTOM	POSSIBLE CAUSE(S)	CORRECTIVE ACTION
A) Water downstream of dryer	<ol style="list-style-type: none"> 1. Residual free moisture remaining in downstream pipelines 2. Air by-pass system is open 3. Inlet and Outlet connections are reversed 4. Air lines downstream of dryer are exposed to temperatures below the dew point. 5. Excessive free moisture (bulk liquid) at dryer inlet 6. Condensate not being drained 7. Dryer overloaded resulting in elevated dew point. 8. Refrigeration system not functioning 	<p>Blow out system with dry air</p> <p>Check valve positions Check for correct connection</p> <p>Insulate or heat trace air lines exposed to low ambients or dry air to lower dew point Install separator ahead of dryer</p> <p>See C below See C below See C below</p>
B) High pressure drop across dryer	<ol style="list-style-type: none"> 1. Excessive air flow 2. Freezing of moisture in evaporator because of refrigeration system fault 3. Filter loaded with solid particulates 	<p>Check flow rate</p> <p>See C below Replace filter element</p>
C) Checkpoint faults <ol style="list-style-type: none"> 1. Power on/off light 2. Compressor on light off 3. Alarm/Service alert light on - check Display for active conditions SERVICE DRYER <p>LOW PRESSURE</p> <p>HIGH PRESSURE NOTE: If high refrigerant pressure occurs, switch must be manually</p> <p>LOW TEMPERATURE (also observed as low reading on temperature indicator)</p> <p>HIGH TEMPERATURE (also observed as high reading on temperature indicator)</p> <p>DRAIN</p> <p>TIME OUT</p>	<ol style="list-style-type: none"> a. Power failure; open circuit a. Compressor commanded off by manual switch or programmed schedule b. Open circuit c. Control circuit open on high or low pressure cutout <p>Service interval specified has elapsed</p> <ol style="list-style-type: none"> a. Hot gas by-pass valve requires adjustment b. Low on refrigerant <ol style="list-style-type: none"> a. Lack of condenser cooling Air-cooled - Ambient temperature too high, clogged condenser fins, obstructed flow across condenser, faulty fan motor or fan control switch. Water-cooled - Cooling temperature too high, flow too low, clogged strainer, faulty water regulating valve a. Hot gas by-pass valve requires adjustment a. Dryer overloaded b. Refrigeration system off or not cooling sufficiently a. Drain line restricted or frozen b. Drain mechanism faulty <p>Dryer left in the Set Mode for longer than 30 seconds</p>	<p>Check for power to dryer</p> <p>Check current command status</p> <p>Check power to compressor Check display for fault</p> <p>Perform scheduled service</p> <p>Contact qualified technician or manufacturer's service department</p> <p>Check air temperature 6" in front of condenser Clean condenser and check for free air flow Check fan and switch operation Check cooling medium temperature and flow, clean strainer, check valve operation</p> <p>Contact qualified technician or manufacturer's service department</p> <p>Check compressed air flow, temperature, and pressure</p> <p>Check power to unit, power to compressor, Low or High pressure faults Have qualified technician evaluate system</p> <p>Open drain line Turn 3-way valve to horizontal position and open petcock for manual draining. Rebuild drain mechanism. Finish programing and press Set/Run button</p>

NOTE: After fault correction, press reset button to clear display

For Sales & Service Call: 705-722-5747 Ext.1

PARTS LIST

PARTS DESCRIPTION	208-230/3/60				380-420/3/50, 460/3/60, and 575/3/60			
	200	250,300	400,500	750	200	250,300	400,500	750
Condensing Unit (air-cooled)	4130.127.16	4130.127.19	4130.125.14	4130.129.1	4130.127.17	4130.127.20	4130.125.15	4130.129.2
Compressor	4130.108.53	4130.108.55	4130.108.57	4130.108.64	4130.108.54	4130.108.56	4130.108.58	4130.108.65
Fan motor	6105.238.37	6105.238.39	6105.238.39	6105.238.39	6105.238.38	6105.238.40	6105.238.40	6105.238.40
Fan blade	4140.227.22	4140.227.23	4140.227.24	4140.227.24	4140.227.22	4140.227.23	4140.227.24	4140.227.24
Crankcase heater	5920.327.12	5920.327.12	5920.327.12	5920.327.12	5920.327.13	5920.327.13	5920.327.13	5920.327.13
Condenser (air-cooled)	4130.111.23	4130.111.24	4130.111.25	4130.111.28	4130.111.23	4130.111.24	4130.111.25	4130.111.28
Low refrigerant pressure switch	4130.138.22	4130.138.22	4130.138.22	4130.138.22	4130.138.22	4130.138.22	4130.138.22	4130.138.22
High refrigerant pressure switch	4130.138.25	4130.138.25	4130.138.25	4130.138.25	4130.138.25	4130.138.25	4130.138.25	4130.138.25
Fan cutout switch 1	4130.138.23	4130.138.23	4130.138.23	4130.138.23	4130.138.23	4130.138.23	4130.138.23	4130.138.23
Fan cutout switch 2	---	---	4130.138.24	4130.138.24	---	---	4130.138.24	4130.138.24
Condenser (water-cooled)	4130.137.44	4130.108.62	4130.108.46	---	4130.137.45	4130.108.63	4130.106.47	4130.106.56
Water control valve	4130.145.22	4130.145.22	4130.145.22	---	4130.145.22	4130.145.22	4130.145.22	4130.145.23
Water strainer	4731.735.1	4731.735.1	4731.735.1	---	4731.735.1	4731.735.1	4731.735.1	4731.735.1
Screen, water strainer	4731.735.5	4731.735.5	4731.735.5	---	4731.735.5	4731.735.5	4731.735.5	4731.735.5
Maintenance Kits	RDMK6C	RDMK7C	RDMK8C	RDMK9C	RDMK6C	RDMK7C	RDMK8C	RDMK9C

For Sales & Service Call: 705-722-5747 Ext.1

Warranty

The manufacturer warrants the product manufactured by it, when properly installed, operated, applied and maintained in accordance with procedures and recommendations outlined in the manufacturer's instruction manuals, to be free of defects in material and workmanship for a period of one (1) year from date of purchase at the retail level by the end user, not to exceed eighteen (18) months from the date of manufacture, provided such defect is discovered and brought to the manufacturer's attention within the aforesaid warranty period.

The manufacturer will repair or replace any product or part determined to be defective by the manufacturer within the warranty period, provided such defect occurred in normal service and not as the result of misapplication, misuse, abuse, neglect, incorrect maintenance, accident, or normal wear. Normal maintenance items requiring routine replacement are not warranted.

The warranty covers parts and labour for the warranty period. Repair or replacement shall be made at the sole option of the manufacturer. Any service performed on the product by anyone other than the manufacturer must first be authorized by the manufacturer. Unauthorized service voids the warranty and any resulting charge or subsequent claim will not be paid.

Products repaired or replaced under warranty shall be warranted for the unexpired portion of the warranty applying to the original product, based on the original date of purchase and/or date of manufacture, as outlined above.

There is no other expressed warranty. Implied warranties including those of merchantability and fitness for a particular purpose are limited to one (1) year from date of purchase to the extent permitted by law and any and all implied warranties are excluded. This is the exclusive remedy. Liability for consequential damages under any and all warranties are excluded to the extent exclusion is permitted by law.

This warranty gives you specific legal rights, and you may also have other rights within your jurisdiction.

This warranty does not cover:

1. Merchandise that has become inoperative because of ordinary wear, misuse, negligence, accident, or improper and unauthorized repair or alteration.
2. Costs occasioned by the removal, replacement, or repair of merchandise (other than by Devair) without previous written authorization.
3. Expenses incurred in travel or lodging beyond a 40 kilometer (25 mile) distance from the nearest Devair Authorized Service Centre, unless approved by Devair in advance.
4. Products, parts, materials, components, or accessories manufactured by others or supplied in connection with the sale of the manufacturer's products.
5. Repair and transportation costs of merchandise determined not to be defective under the terms and conditions of this warranty.

All decisions by Devair Inc. with regard to this policy shall be final. Devair will not be responsible for any claimed defective materials returned other than in accordance with this statement of policy or without our prior authorization.

For Sales & Service please contact:

CENTRAIR Air Systems & Supplies

Phone: 705-722-5747

Fax: 705-722-5458

Email: sales@centrair.ca

Website: www.centrair.ca



Devair Inc.

Formerly DeVilbiss Air Compressor Products